



CTS is a 7-day programmable intelligent thermostat designed for electronic floor heating systems, which is touch screen operation with smart appearance.

Main Features

- 2.4" TFT color screen, resolution 320x240pixel
- Full screen touch operation (resistance-type)
- Energy monitoring function
- Frost protection function
- Multi language OSD menu optional
- USB port charging, easy to operate
- Support various types NTC sensors
- Compatible with several frame systems for electrical appliances
- First warming function
- Child lock function
- Support Holiday mode

Technical Specification

Supply voltage: 2 x AA 1.5V alkaline batteries, 230V
 Maximum Load: 250VAC 16A
 Room temperature limit: 5°C (41°F) ~ 35°C (95°F)
 Floor temperature limit: 5°C (41°F) ~ 45°C (113°F)
 Ambient temperature-operation: 0°C (32°F) ~ 50°C (122°F)
 Ambient temperature-transport: -10°C (14°F) ~ 60°C (140°F)
 Accuracy: ±1°F or ±0.5°C
 Dimensions: 83.5(L)x83.5(W)x39.5(H)(cm)
 Color: White
 IP class: 21

Summary of Contents

1	Introduction.....	3
1.1	Starting up.....	3
1.2	Operation mode.....	3
2	Menu Optional.....	4
2.1	Program setting.....	4
2.2	View program.....	5
2.3	Energy monitor.....	6
2.4	Settings.....	8
2.5	Time setting.....	11
3	Installation.....	12
4	Error Message.....	13

Safety introduction

Please observe the following guidelines:

- Do not cover the thermostat, e.g. by hanging towels or similar items in front of it! This will impair the ability of the thermostat to sense and adjust the room temperature correctly.
- Do not spill liquids of any kind into the thermostat.
- Do not open, disassemble, or tamper with the thermostat in any way.
- If the thermostat is installed in a place frequented by small children, use the child lock.
- Do not interrupt the power supply to the thermostat.
- The installation of the thermostat must be done by an authorized and qualified installer according to local regulations.

The switch button introduction:

When the thermostat is installed and powered, you need to push up the switch button to activate the screen, and then start the following settings.

First time settings:

When you open the thermostat first time, you will see the SASWELL logo on the display screen, and then it will require you into the following setting:

- Language setting → Time setting → Date setting →
- Display color setting → Backlight setting → Control setting →
- Floor type setting → Load setting

The default screen after you setting is as following:

It shows important information such as time, date, Current room or floor temperature, current programming time as well as the target set temperature.

Operation Mode:

The factory default mode is program operation mode, You can also select other operation modes according to the following settings.

Holiday Mode:

Press **Menu** access the menu page, select **Program** into the holiday mode. Press the **▲** or **▼** to set the holiday start date and end date, also the holiday temperature, press **Apply** to save your setting.



Manual Mode:

In the home screen, you can also touch any place to override the current schedule, press **▲** or **▼** to set the temperature you want, and then press **Hold** into the Permanently hold mode, press **Apply** into the Temporary override mode. When the thermostat is in manual operation mode, you can press **Quit** back to program mode.

Frost Mode:

Press the button at the right side of the Thermostat, don't release until the screen shows symbol, this mode maintain a minimum temperature for frost protection. (5°C open, 8°C closed).

General operation:

Back

Various menus and submenus contain a Back option. Use Back to return to the previous step.

Apply Various menus and submenus contain an Apply option. Use Apply to confirm your setting.

If you do not press any button on the thermostat for 1 minute, then it will go back to home screen.

Whenever you are setting the thermostat, you can press the button on the middle of it to back to home screen.

Menu Optional

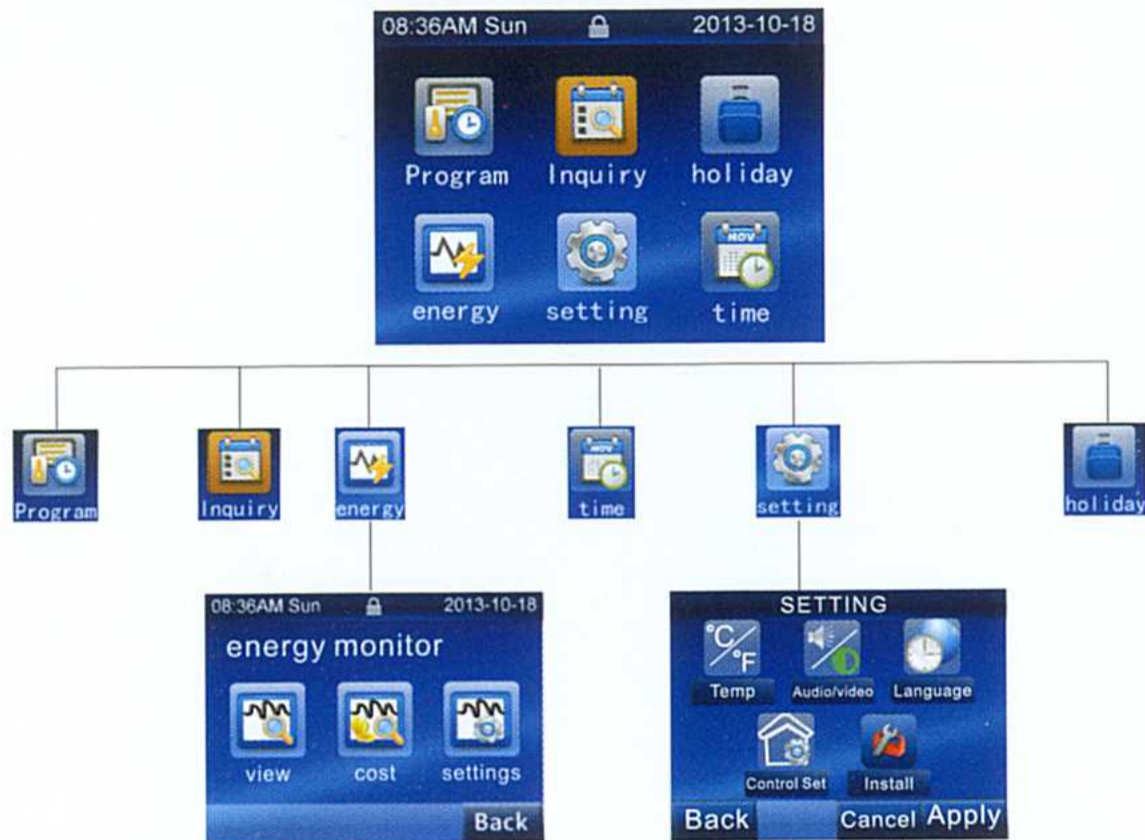

Program setting :

Select the days (Monday-Sunday) you wish to make changes, press **Apply** into the temperature and time setting, then adjust the start time or temperature of different time period by pressing **▲** or **▼**, press again **Apply** to save your setting.

The program setting interface is as following:

There are total 6 time period in one day, get up in the Morning, go out of home in the morning, back home At the noon, go out of home in the afternoon, back Home in the evening, and sleep at night.



You can make the same setting of 7 days (Monday to Sunday), when you finished the one day's setting, The zone will be gray, it means that you cannot set again.

The factory default program period and temperature chart are as following:

	Time	Temp	Time	Temp	Time	Temp	Time	Temp	Time	Temp		
All 7 days	6:00	21°C	8:00	16.5°C	12:00	21°C	14:00	16.5°C	18:00	21°C	22:00	16.5°C

View and edit program:

Select the day you want to view, e.g.: Monday-Sunday, press **Apply** then you can see the summary diagram of the set time period and temperature. Press **Edit** reset the program time and temperature if you are not satisfied with the current schedule.



View energy cost

Select the time period you want to view, and press **Apply** into the diagram show. The diagram shows the energy cost summary of the selected period. Press **OK** back to the time period option.

The energy cost estimate will only be accurate for the time period AFTER you set the heating costs.



Energy monitor:

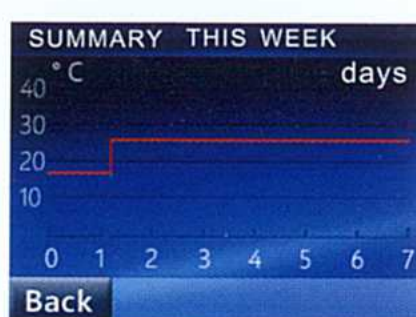
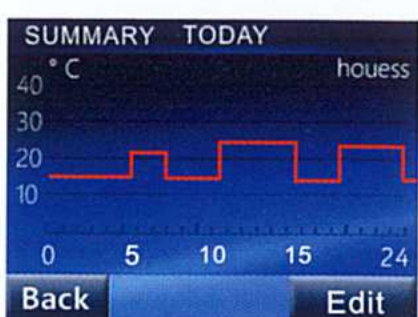

View energy use

Select the time period you want to view, and press **Apply** into the diagram show. The diagram shows the energy use summary of the selected period. Press **OK** back to the time period option.

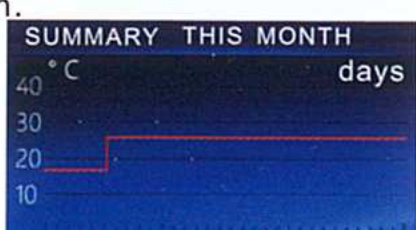

Energy parameter settings

In this interface, you can set the Load and Tariff. Select the work voltage, and then press **▲** or **▼** to set the load. Press **Apply** to confirm your setting.

Set the Low tariff time and unit price. According your local living habit to set the low tariff start time and end time by pressing **▲** or **▼**, press **NEXT** into the unit price setting.



Set the unit price of electric at the standard tariff and low tariff, according to your local actual electricity price. Press **Apply** to confirm your setting.



Temperature unit settings

Select the "°C" or "°F" according to your preference.



Video Setting

Theme

- Change the content and style of home screen and standby screen, there are "Blue" and "Black" two colors.

Display brightness

- Set the brightness of the LCD screen in normal operation between 1 (dimmet) and 3 (brightest).

Standby brightness

- Set the brightness of the LCD screen in standby mode between 0 (dimmet) and 3 (brightest). If you choose "0", Note: when set it to "0" the LCD screen will turn OFF, you need to turn on the screen by pressing the unlock button on the side of the thermostat.

Child Lock

- The child lock is used for locking the screen display in order to prevent undesirable changes of the thermostat settings. Press the button at the right side of the thermostat shortly, then the screen will be locked.



Language setting

Select the operation language you prefer. There are multi-language optional (English, French, German, Dutch, Russian, Polski, Norsk, Svenska, Danish, Suomi, Romania).

Control object setting

Select the control object if your thermostat use floor temperature sensor for thermal regulation.

Set room temperature

The thermostat will use the temperature reading from the room sensor (inside thermostat housing) to decide whether heating is required to achieve the target set temperature.

Select floor temperature

The thermostat will use the temperature reading from the floor sensor to decide whether heating is required to achieve the target set temperature.

Set room temperature with floor limit

Thermostat will use the temperature reading from the room sensor to decide whether heating is required to achieve the target set temperature, however if the floor temperature goes above the set limit then heating will be suspended until floor temperature falls below limit.



Install setting

Heat setting

- Set floor type

Select the different floor type according to your room. This setting will affect the upper and lower limits of programmable set temperatures as well as the overheat limit.

If you set a user defined limit then you are advised to check the safe temperature limits with the flooring manufacturer.

- Adaptive

When the auto settings "ON", the thermostat will heat in advance before you back home.

- PI control

When the ratio control "ON", it can make the system heat target temperature more accurate.

- First warming

This function is only need to be open when your room floor is first time be heated, the thermostat will run this function 21 days then stop drying the floor automatic. You can also close it if you don't want to continue drying.

Set offset

If you feel the room temperature is not very comfortable When program operation, you can set the offset temperature, the maximum limit of the offset temperature is 8°C.

Program period set

There are 2 options for how to program the period in one day

P4: You can program 4 periods per day

P6: You can program 6 periods per day

The factory default is P6.

Set floor sensor type

The thermostat is compatible various kinds of floor sensor

Except SASWELL 100K and SASWELL 10K, for example:

DEVI 15K, OJ12K, Eberle 33K, Ensto 47K, FENIX 10K, TYCO 10K, Teplolux 6K8, Warmup 12K, aube 10K.

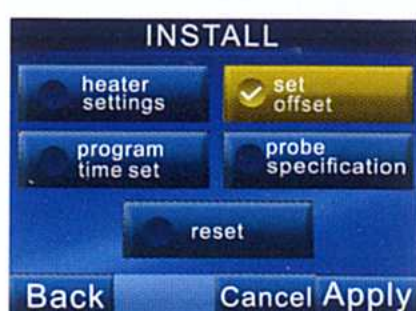
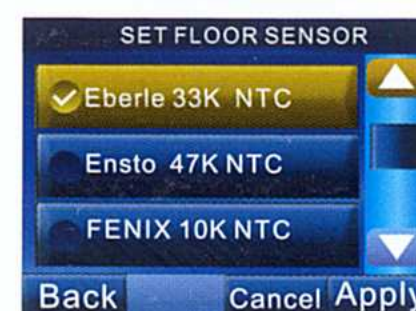

Revert to factory default
 Press RESET button, this will reset the thermostat to factory default setting. Press YES to confirm.



Time Settings

- Set time and date by pressing the ▲ or ▼.
- Set time format preference (12Hr clock or 24Hr clock) and date format preference (YYY/MM/DD or DD/MM/YYY).
- Select the Daylight Saving Time or Normal day format.

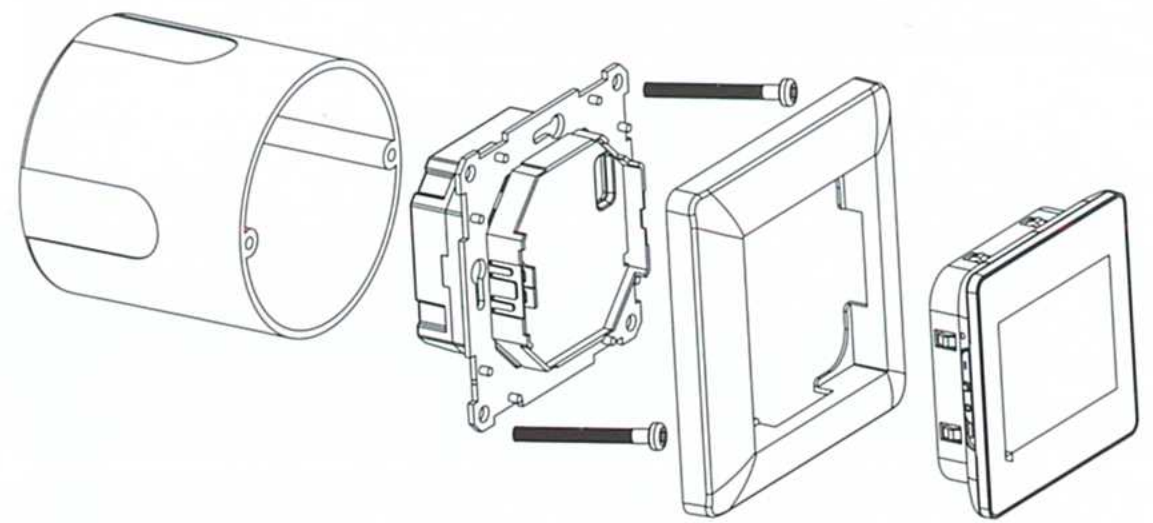

- 1 Remove the front cover by gently pressing the release tabs on both sides of the thermostat. Then remove the frame.
- 2 Connect wires beneath terminal screws on power base using appropriate wiring schematic. See the following wiring diagram.
- 3 The floor sensor cable must be installed to terminal block (See the wiring diagram) in Floor sensor control type or Mix sensor control type, otherwise thermostat will shut down heating output and display will show E2 indicate floor sensor problem.
- 4 Push power base into wall box.
- 5 Using two mounting screws mount the power base to the wall. Place a level against bottom of base, adjust until level, and then tighten screws. (Leveling is for appearance only and will not affect thermostat operation.)
- 6 Replace front cover on the power base by snapping it in place.

WIRING DIAGRAM

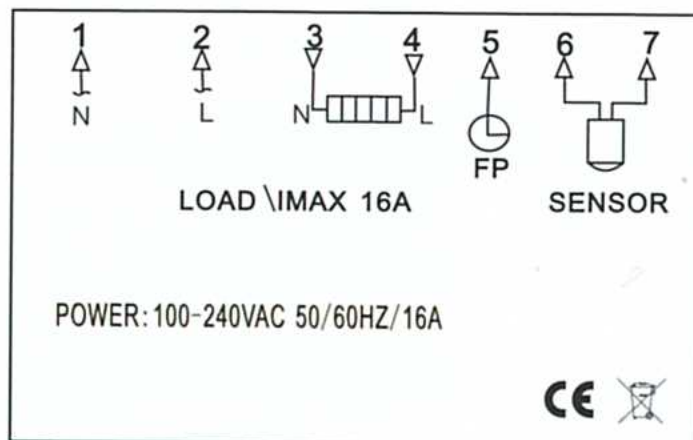

Attention:

- Item 1-2: N: Neutral Wire; L: Live Wire.
- Item 3-4: Connected with heat load.
- Item 5: Pilot wire signal (France).
- Item 6-7: Connected with floor sensor.

Error Message

Error Code

- E1 flashing in the display: Floor sensor short circuit in type F or AF. Thermostat shut down all output.
- E2 flashing in the display: Floor sensor not installed or broken in type F or AF. Thermostat shut down all output.
- E3 flashing in the display: Room sensor short circuit. Thermostat shut down all output.
- E4 flashing in the display: Room sensor broken. Thermostat shut down all output.
- E5 flashing in the display: Floor sensor over high limitation in type F or AF. Thermostat shut down all output.
- E6 flashing in the display: Floor sensor below lowest limitation in type F or AF. Thermostat turn on heating system until the floor temperature is over lowest limitation.