

UTR07b Heating Thermostat User Manual

[General]

- Heating Thermostat with weekly programming adopts the latest single-chip computer control technology.
- It has the high reliability and powerful anti-jamming. It can realization energy-saving and comfortable living environment
- The application is the electric heating equipment and Water heating system of electric heating or actuator control. According to the preset temperature, the thermostat will automatically start and stop the controlled object (valve, floor heating, the heating wall, electric heater etc).
- Multiple time modes: 5+2/6+1/7days, the heating equipment supports different temperature setting accordingly with 6 time-modes daily. Users are free to choose manual mode or full automatic mode for different purposes.
- Using flame resistance material, the heating equipment is safe and reliable. Its appearance is stylish and its mirror screen would be very easy to clean.
- The clock would continue to run even if power was cut off and it will not affect the period setting value.
- Keypad locking function is designed to prevent the children from misusing.

[Technical parameters]

- Power Supply: 85-250VAC 50/60 Hz
- Internal sensor measurement range: 0 - 40°C.
Setting range: 5 - 35°C (factory settings: 25°C)
- Inside sensor: NTC B=3380
10k @25degrees Celsius
- Display type: LCD, Display area: 60 x 45 mm
- The maximum switch power: 2A/16A
- External sensor measurement range: 0 - 99°C.
Setting range: 5 - 95°C (factory settings: 50°C)
- Extra sensor: NTC B=3380 10k @25 degrees Celsius,
length=3 meters (optional)
- Display resolution: 0.1°C Setting Unit: 0.5°C/step

Operation Guide

[On and off]

Press  keys you can

turn on or turn off the thermostat.

The display would be as the following

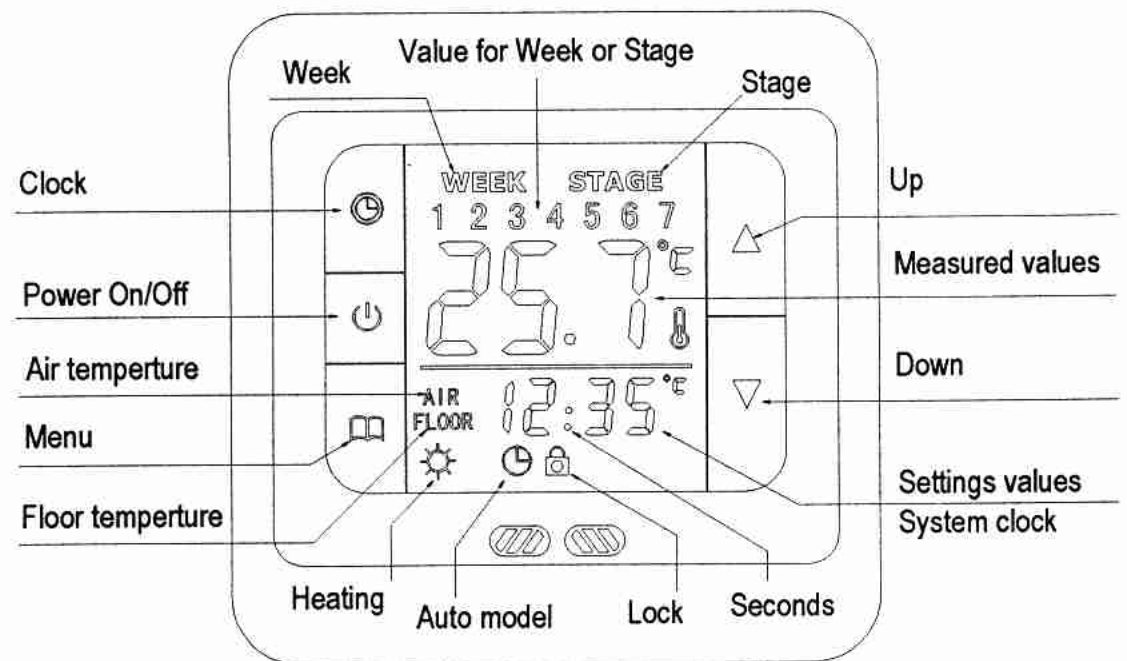
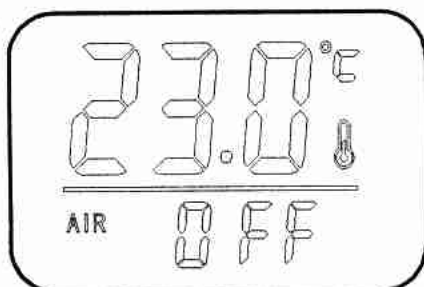

When turning off.









[Display three kinds of temperature]

The thermostat works for temperature control in mode **IN** and mode **ALL**. The main screen shows air temperature or room temperature when AIR icon lit, the vice-monitor would set temperature every 5 seconds and alternatively display current time.

When the thermostat is in **OUT** mode, the FLOOR icon will be lit. The main screen will display floor temperature or external sensor location.

When the temperature is in mode **ALL**, press  and  can detect floor temperature or external sensor location, and the FLOOR icon will be lit. The main screen will automatically display air temperature 5 seconds later after the AIR icon lit.

[System time]

How to set the system time: Keep pressing  for 5 seconds, it will enter into the time setting. The current revisable object will flash and display. Press  and choose time you want to revise (week / hour / minute), press  or  to modify the current setting. If you need to modify the previous parameters, please press  key. After the modified minutes you can press  to exit the system clock settings.

[Automatic / manual switch]

Press  you can choose the manual mode or automatic mode.

Manual mode: System will control temperature under the set value without any change.

Automatic mode: System would control temperature according to the preset temperature values in different time. The icon ☰ will lit, which means that the system is running under automatic mode. The **week** and **Stage** icon would alternately display every 5 seconds, 1-7 is systematic reuse. When screen shows **WEEK**, 1-7 would display the values of the week. When screen shows **STAGE**, 1-6 would display the current values.

[Setting the periods of time modes]

The periods setting can realize the control of temperature and time under automatic mode. Once setting up, the values could be saved and reused in the thermostat forever.

The thermostat can save three kinds of schedules (5+2 / 6+1 / 7) in 6 periods; One week for a cycle.

Each data is saved as the start time (hours: minutes) and the temperature degree of this period. The end time of the period would be saved as the start time of next period. You can also shut down a certain period according to your actual needs.

Press the ☰ for 5 seconds, you will enter into the period setting (See the following). Press button ☰ to select the object you want to modify (the period start time: hours, minutes and set temperature), press ▲ or ▼ to modify the corresponding value. If you want to turn off a period, please press ▼ until the **OFF** option shows. You can use the ☰ to back to the previous setting.

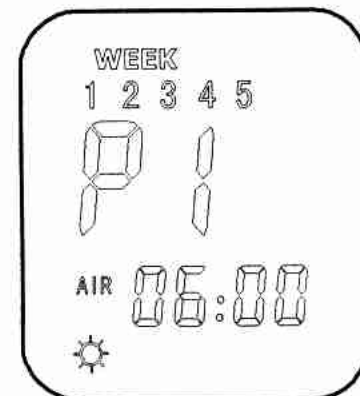

The system's default period is 5+2. For specific data, please see the following table. User can modify the value by entering into the programming interface:

5+2 mode	ID	P1	P2	P3	P4	P5	P6
Monday to Friday	Start time	06:00	08:00	11:30	12:30	17:00	22:00
	Set value	22°C	15°C	15°C	15°C	22°C	15°C
Saturday to Sunday	Start time	06:00	08:00	11:30	12:30	17:00	22:00
	Set value	22°C	15°C	15°C	15°C	22°C	15°C

For example: When the system time is Friday 08:20 under automatic mode, display would show as: **STAGE 2** and the setting temperature value would be 15 degrees.

The thermostat can't quit when you set the periods, it will automatically exit when all setting is finished.

[Children Lock] Press key ☰ ☰ for 2 seconds at the same time, the controller keypad would be locked. Screen would show ☰. Press the ☰ ☰ at the same time for 2 seconds under the locked status, keypad would be unlocked.

[Temperature control mode]

According to the sensor setting of thermostat, there are three different control modes, enter the advance function to set.

Internal control (IN): Only enable built-in sensor temperature measurement, the temperature control is based on the built-in temperature sensor. It is suitable for the detection of air temperature or the room temperature.

External control (OUT): Only enable external sensor to temperature measurement, the temperature control is based on the external sensor. It is suitable for the detection of the heating body temperature.

Dual temperature control (ALL): Temperature control is based on the built-in temperature sensor and an external temperature sensor (over-temperature protection). It is suitable for the detection of room temperature and heating body whether over temperature monitoring. If the external sensor is over temperature, thermostat will shuts down the heater.

[System setting]

Warning: System setting is used to set some important parameters of the system, that's only for professionals. Do not make any improper modification. The item already been debugged and tested by professionals, there is no need to reset.

Enter the system setting: Press ☰ to switch on the thermostat when the unit is turned off. Within the next second please press Key ☰ as soon, you will enter into system setting. You can press ☰ to switch the system parameters. At the same time press ▲ or ▼ to modify settings. Select a set value. If you do not press the ▲ or ▼, the parameters would not be modified. If you want to save the data, you must go through all the functions then exit the system menu.

The system parameters according to the following order: Adj->PrG->LtP->SEn->Top->dt0->dt1->bL->Sat->dEF

The thermostat's display type is LCD segment displaying. There are some differences between the displayed value and practical value. Please make reference to the specific figure:

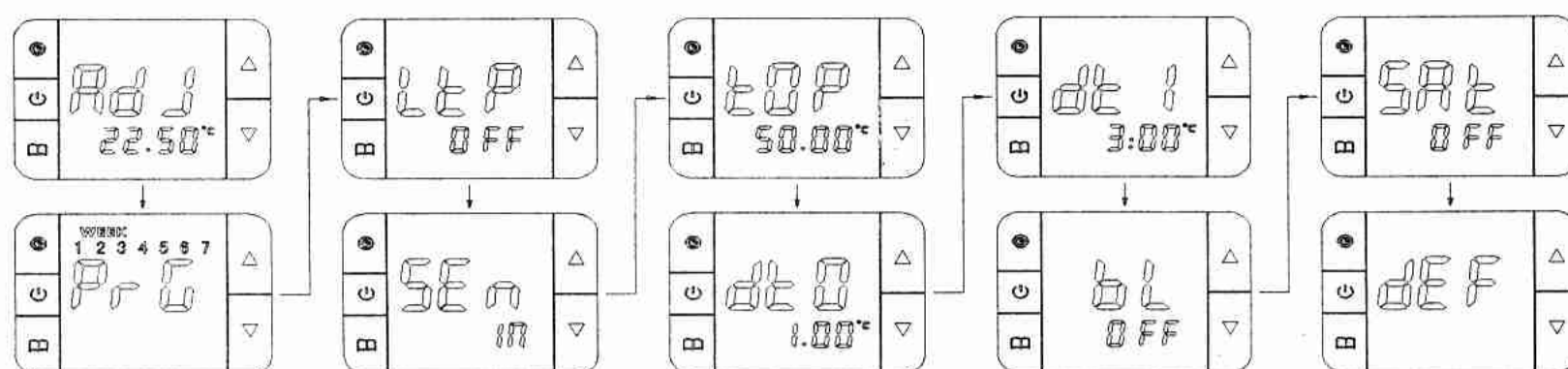

Display	Set the content	Adjustment range	The default value
Adj	temperature correction	-5°C ~ 5°C	-2.5°C
	Used to correct the sensor value, screen would show the value needed to be revised when adjusting; the revised value will be displayed after 3 seconds.		
PrG	The period-time mode	5+2 / 6+1 / 7	5+2
	5+2: Monday to Friday is set as the same; Saturday to Sunday is set as the same. 6+1: Monday to Saturday is set as the same. Sunday is individually controlled. 7: Monday to Sunday is set as the same.		
LtP	Antifreeze	On: Enable / OFF: Disable	OFF
	Low temperature protection, what is suitable for the water system To prevent the pipe from freezing at low temperature.		
Sen	Sensor or temperature control mode	IN: Built-in OUT: External ALL: Dual temperature control	IN
	IN: internal control, room sensor Out: external control, floor sensor ALL: double temperature double control, the internal room temperature sensor, external sensor overheating protecting		
tOP	External temperature sensor limit	40-80°C	50°C
	The sensor is set to ALL, the temperature limit external sensor value		
dt0	Internal sensor hysteresis	0.5-4°C	1°C
	Built-in temperature sensor hysteresis		
dt1	External sensor hysteresis	0.5-5°C	3°C
	External temperature sensor hysteresis		
bL	Backlighting status	On: Always on OFF: Auto turn off after 5sec	OFF
	Backlight lighting mode, can be set according to personal preference		
Sat	Status at re-power	OFF: off status at every time On: the same as previous,	OFF
	Used to control the power state of the boot		
dEF	Restore factory settings	Restore factory settings	To restore the default

[The error and solution of common system]

1. Fault phenomenon : There is no display

Reason & solution:

- 1、 Power supply system is having problems or power is supplied incorrectly, please check if the inlet wire is normal.
- 2、 If the connection is not right, please wired up as the wiring diagram on the back side.
- 3、 Actual temperature is too low, please note the thermostat temperature range. If the temperature is lower than -5 °C, the unit cannot normally display.
- 4、 Power supply box and the motherboard Coupling is not connected correctly, please connect correctly.
- 5、 Power supply box and the motherboard Coupling are opposite inserted, please mind the direction

6. Power supply box and the motherboard Coupling is broken, please don't overexert. Coupling length is 6cm, the installation must be careful. If damaged, no warranty and replacement

2. Fault phenomenon : Display rupture

Reason solution: Display encounters hard objects or sudden force, no replacement and warranty

3. Fault phenomenon : Display a black screen

Reason solution: If the display surface temperature is too high, please note whether there is heater nearby, if so please remove.

4. Fault phenomenon : Display ER0 or ER1

Reason solution:

ER0: If built-in sensor is abnormal, please pay attention to whether the small black dot in temperature sensing window was damaged during removal

ER1: The system is set in the dual temperature control (ALL) mode, or it is not connected with an external sensor, or the external sensor is abnormal.

5. Fault phenomenon : No pen on LCD

Reason solution: Please check whether the iron plate is deformation when installation. If it is deformation, please correct it.

6. Fault phenomenon : No backlight

Reason solution: Please check whether backlight lamp connection is broken when removing in the panel.

7. Fault phenomenon : Backlight always bright

Reason solution: 1、The ON is set in the system menu bL 2、If it is damaged, please replace it.

8. Fault phenomenon : Large deviation of measurement temperature and the actual temperature

Reason solution: 1、The thermostat should be installed at ventilated place. It can not be installed at the place in direct sunshine or nearby the heater 2、Back connection screw is not locked, causing terminal serious fever

9. Fault phenomenon : Display 0 degrees

Reason solution: It is normal if thermostat display 0 degrees when the actual environment is below 0 degrees.

The above is some of the most common errors, if you can't solve, please contact the local dealer!

[Dimension in mm]

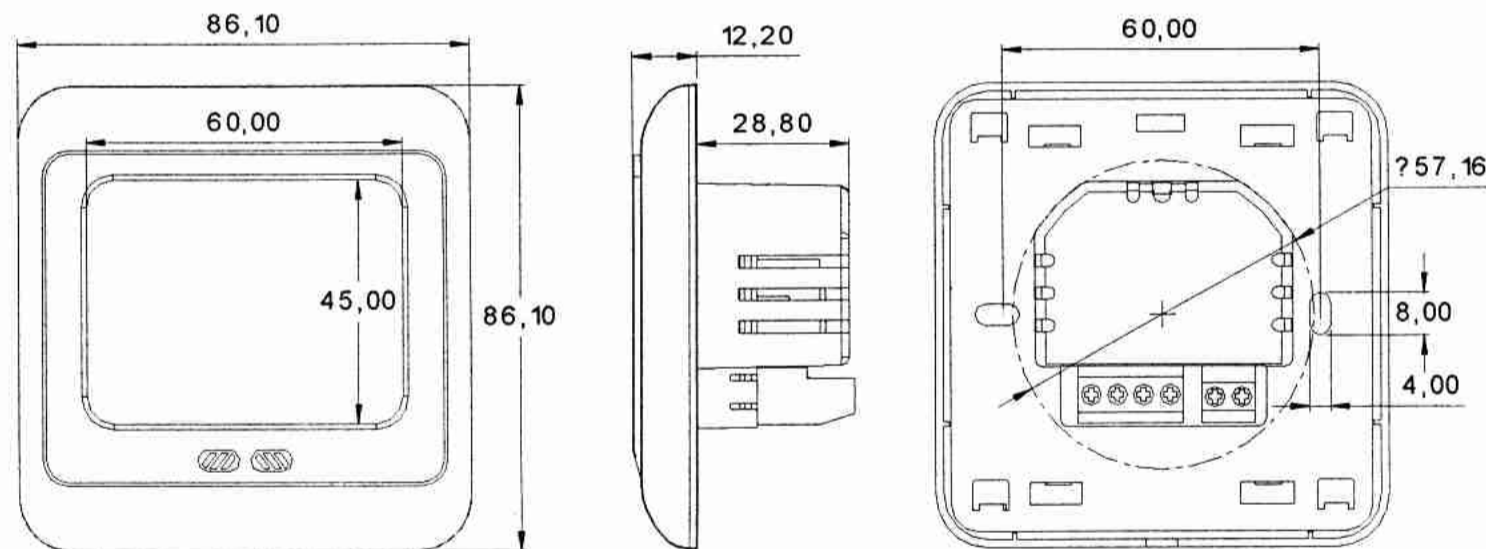

[Installation Diagram]

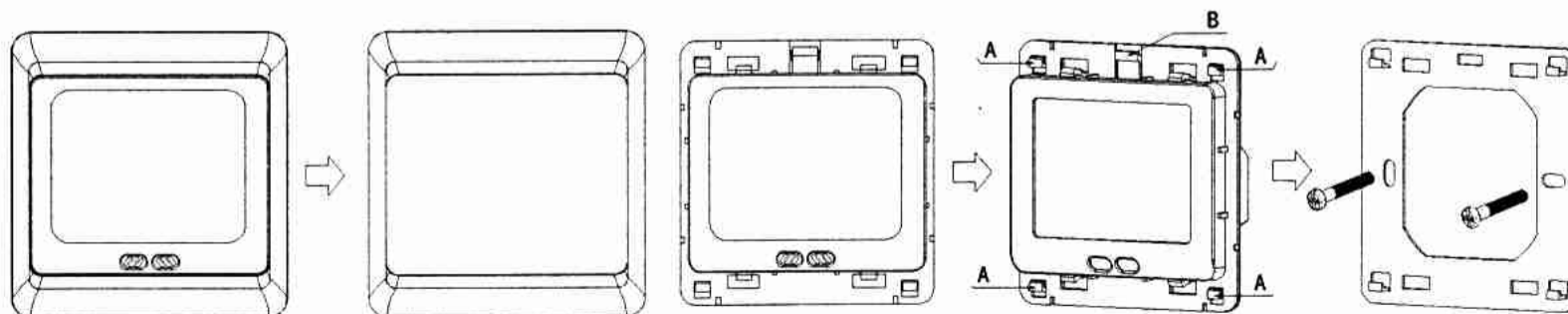

Step 1: Separate the Polycarbonate Bezel unit from the LCD screen.

A: Hook

B: Buckle

Step 2: In Laka buckle, outside at the same time lift up the movement, it is necessary to separate the iron with the movement.

Step 3: Fixing plate with screws to the wall to ensure that the de-energized state product back wiring diagram connected electrical lines.

Combinations: Align the four hooks, press down on the movement, the iron plate with movement combinations, and then fasten the frame